



# **RUPS1612RT**

v.1.0

## **RUPS 13,8V/12V/20A/TOPIC**

**RACK mounted buffer power supply for up to 16 cameras and recorder.**

**EN**

Edition: 3 from 15.11.2017

Supersedes the edition: 2 from 30.03.2017



**Features:**

- DC 13,8V/16x0,75A uninterruptible power supply for powering HD cameras ( $\Sigma I=12A$  max.)
- DC 12V/4A uninterruptible power supply of the recorder
- 16 outputs to cameras independently protected with 1A glass fuses
- the output for the recorder is protected with the 4A glass fuse
- wide range of mains supply AC: 176÷264V AC
- high efficiency 82%
- battery charging and maintenance control
- excessive discharging (UVP) protection
- battery output protection against short circuit and reverse connection
- battery charge current: 2A (batteries 1x17Ah / 1x28Ah / 1x40A / 1x65Ah)
- control of voltage presence at the AUX1 ÷ AUX16 outputs DVR
- Approximate backup time: 4h 30min
- acoustic indication of failure
- LED optical indication: AC, DC, TEMP, LoB, ALARM, AUX1 ÷ AUX16, DVR
- the ALARM technical output of collective failure –relay type, activated by:
  - 230V AC power loss
  - low voltage of the PSU (<11,5V)
  - activation of the output fuse in the camera power supply circuit
  - activation of the output fuse in the recorder power supply circuit
  - too high temperature of the PSU (>70°C)
  - the PSU failure
- protections:
  - SCP short-circuit protection
  - OVP overvoltage protection
  - overvoltage protection
  - overload protection OLP
- forced cooling (fan)
- warranty – 2 year from the production date

**Sample application of the RACK power supply unit.**

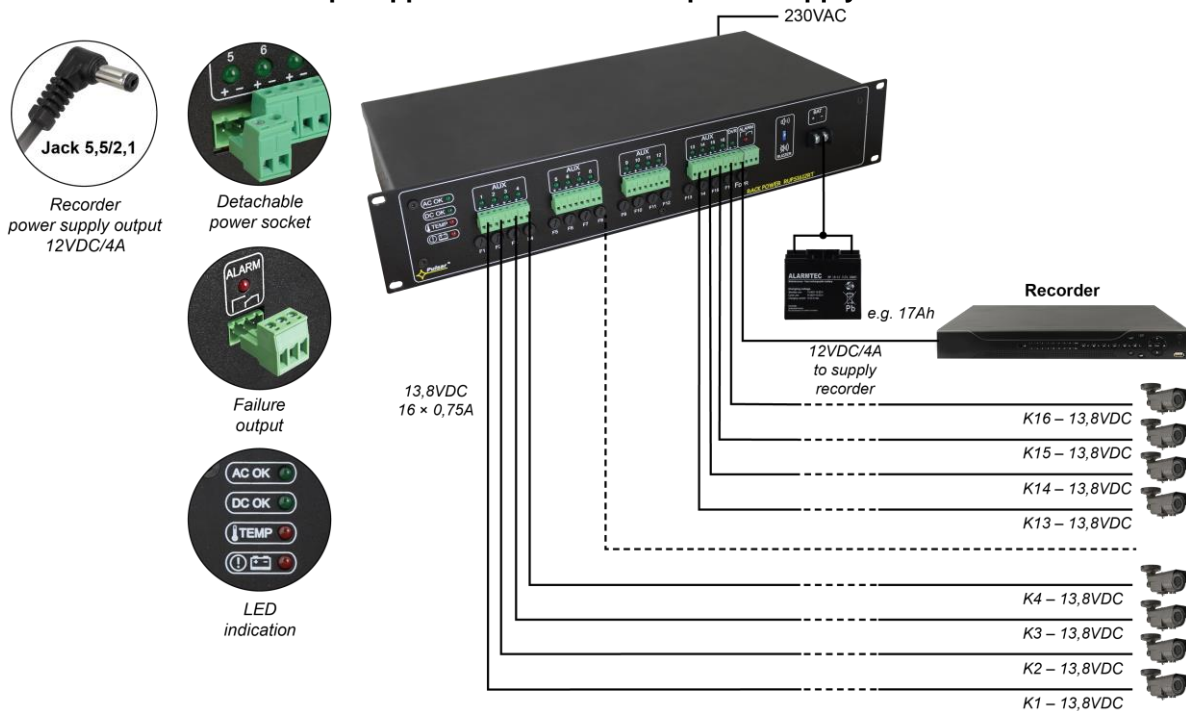

**CONTENTS:**

1. Technical description.
  - 1.1. General description
  - 1.2. Block diagram
  - 1.3. Description of PSU components and connectors
  - 1.4. Specifications
2. Installation.
  - 2.1. Requirements
  - 2.2. Installation procedure
3. Operating status indication.
  - 3.1. LED indication
  - 3.2. Technical output
  - 3.3. Acoustic indication
4. Operation and use.
  - 4.1. Overload or short circuit of the PSU output
  - 4.2. Battery-assisted operation
  - 4.3. Maintenance

**1. Technical description.**

**1.1. General description.**

The RUPS1612RT buffer power supply unit is designed for uninterrupted power supply of up to 16 HD cameras requiring stabilized voltage of **12V DC (+/- 15%)**. The PSU has two circuits: **1x4A / 12V DC** for supplying the recorder and **16x0,75A / 13,8V DC** for both cameras. Current efficiency of the PSU amounts to:

**Output current 16x0,75A + 4A recorder + 2A battery charge  
Total device current + battery: 18A max.**

In case of power decay, a battery back-up is activated immediately.

The approximate backup time is given assuming that all output ports are used (using typical devices and 65Ah batteries). The electricity consumption for own needs and the energy efficiency of the power intake track were taken into account. The exact description of how to perform the calculations can be found at: ["Approximate backup time - assumptions for calculations"](#).

The PSU is fitted with 16 outputs protected independently with glass fuse 1A and the output for the recorder is protected with the 4A glass fuse. The power supply is fitted with the ALARM output of collective failure. In case of failure, relay contacts are switched automatically, which is accompanied by acoustic and optical indication (the corresponding led goes on). The power supply construction is based on the switch mode PSU with high energy efficiency and is located in an enclosure adapted for mounting in standard **RACK 19"** cabinets.

**1.2. Block diagram.**

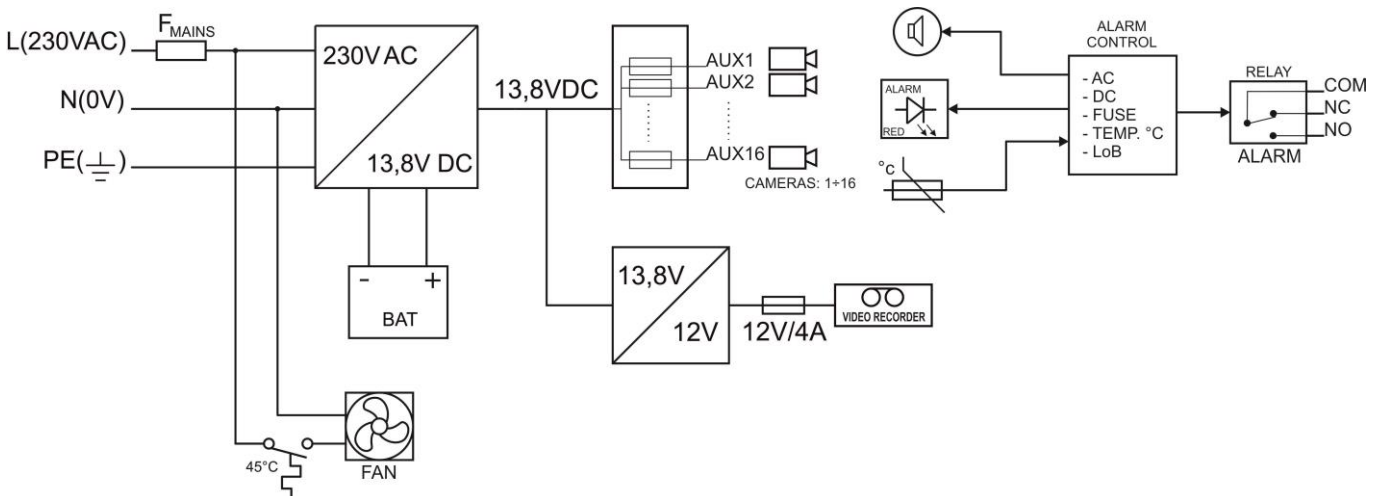



Fig.1. The block diagram of the PSU.

**1.3. Description of PSU components and connectors.**

**Table 1. Elements of the PSU.**

Element no. [Fig. 2, 3]	Description
①	AC OK – green LED, indicating the presence of 230V voltage
②	DC OK – green LED, indicating the presence of DC voltage
③	TEMP – red LED, indicating too high temperature of the power supply (>70°C)
④	LoB – red LED, indicating too low battery voltage (<11,5V)
⑤	LED ALARM – red LED failure indication
⑥	Green LED AUX1 ÷ AUX16 – voltage indication at the AUX outputs
⑦	LED DVR – Green LED voltage indication at the DVR outputs
⑧	AUX1 ÷ AUX16 – independently protected outputs to cameras
⑨	DVR – independently protected outputs of the recorder
⑩	BAT – battery output
⑪	ALARM – technical output of collective failure – relay

⑫	<p><b>BUZZER, micro switch, turning ON / OFF of acoustic indication</b></p>  switch in the top position, indication ON  switch in the down position, indication OFF
⑬	<b>F1 ÷ F16</b> , glass fuses in the cameras AUX (+) power supply circuits, F1A
⑭	<b>F<sub>DVR</sub></b> , glass fuses in the recorder DVR (+) power supply circuits, F4A
⑮	<b>230V AC INPUT</b> , power socket 230V AC, power cable 1,5m included
⑯	<b>F<sub>MAINS</sub></b> , fuse in the supply circuit 230V AC, T 6,3A/250V

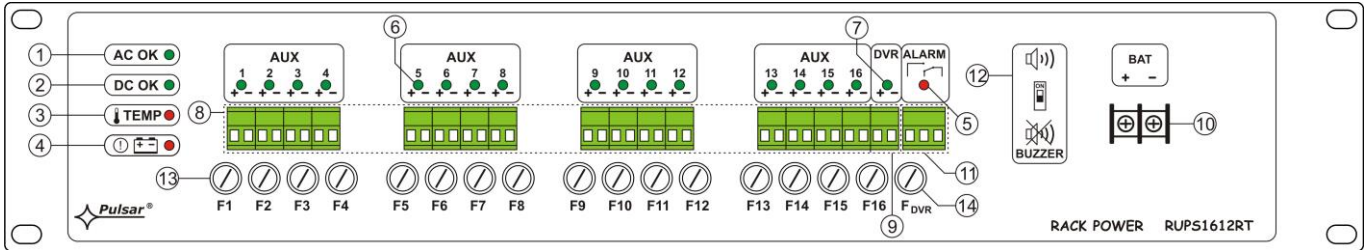

Fig. 2. The front power of the power supply unit.

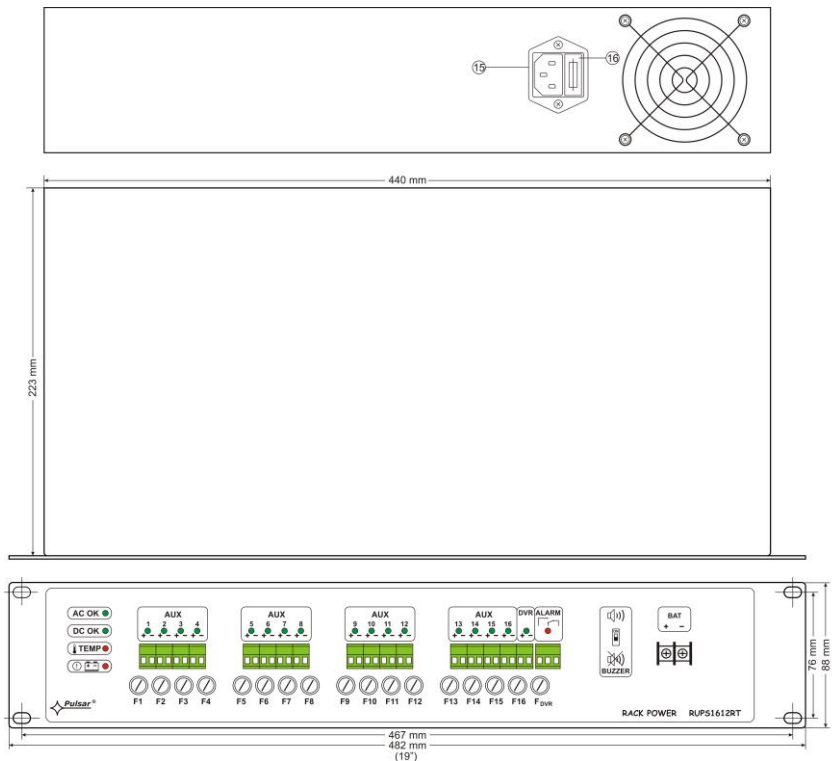

Fig.3. The view of the PSU.

**1.4. Specifications.**

- electrical parameters (tab.2)
- mechanical parameters (tab.3)
- operation safety (tab.4)
- operating parameters (tab.5)

**Electrical parameters (tab. 2).**

Mains supply	176÷264V AC
Current up to	1,3A@230V AC max.
Supply power	241W max.
Efficiency	82%
Output voltage AUX1÷AUX16 - cameras	11V ÷ 13,8V DC – buffer operation 9,5V ÷ 13,8V DC – battery-assisted operation
Output voltage DVR - recorder	12V DC – maintained regardless of the state of battery charge
Output current	<b>16 x 0,75A + 4A recorder + 2A battery charge</b>

Ripple	120 mV p-p max.
Battery charge current (batteries 1x17Ah/ 1x28Ah/ 1x40Ah/ 1x65Ah)	2A max. (+/-5%)
Approximate backup time	4h 30min
Short-circuit protection SCP	cameras: 16 x F 1A, glass fuse recorder: 1 x F 4A, glass fuse
Overload protection OLP	105% ÷ 150% of the PSU power, automatic return
Overvoltage protection OVP	>16V (activation requires disconnecting the load or supply for about 20s.)
Battery circuit protection SCP and reverse polarity connection	glass fuse 30A
Surge protection	varistors
Excessive discharge protection UVP	$U < 9,5V$ (+/-5%) – disconnect of connection battery
Optical indication of operation:	LED: AC, DC, TEMP, LoB, ALARM, AUX1÷AUX16
Acoustic operation indication:	Piezoelectric indicator ~75dB/0,3m
The ALARM technical output of collective failure	Relay type: 1A@ 30V DC / 50V AC
The $F_{MAINS}$ fuse in the 230V power supply circuit	T 6,3A
$F_{DVR}$ fuse in the recorder power supply circuits	F 4A
$F1 \div F16$ , glass fuses in the cameras AUX (+) power supply circuits	16x F 1A

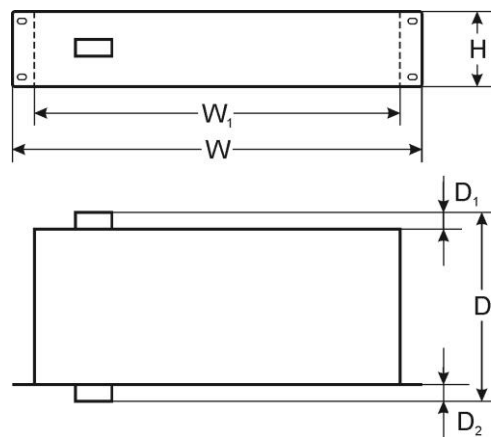

### Mechanical parameters (tab. 3).

Mounting dimensions	$W=19''$ , $H=2U$ , $D=267$
Dimensions	$W=482$ , $W_1=442$ , $H=88$ , $D=267$ , $D_1=32$ , $D_2=10$ [+/- 2mm]
Fixation	four-point butt mounting to RACK profiles – the set include 4 M6 screws + cage nuts
Net weight	6,3kg / 6,7kg
Enclosure	Steel plate RAL 9005, black
Connectors	230V AC input: the IEC C14 socket with a fuse, power cable 2m (included) Outputs: ALARM, AUX1÷AUX16: $\Phi 0,5-2,1$ (AWG 24-12) 0,5-1,5mm <sup>2</sup> Output DVR: $\Phi 0,5-2,1$ (AWG 24-12) 0,5-1,5mm <sup>2</sup> , power cable 2m (included) Battery output BAT: 6,3F-2,5
Notes	Forced cooling (fan).

### Operation safety (tab.4).

Protection class PN-EN 60950-1:2007	I (first)
Protection grade PN-EN 60529: 2002 (U)	IP20
Electrical strength of insulation: - between input and output circuits of the PSU (I/P-O/P) - between input circuit and PE protection circuit (I/P-FG) - between output circuit and PE protection circuit (O/P-FG)	3000 V/AC min. 1500 V/AC min. 500 V/AC min.
Insulation resistance: - between input circuit and output or protection circuit	100 M $\Omega$ , 500V/DC

**Operating parameters (tab.5).**

Environmental class	II
Operating temperature	-10°C...+45°C
Storage temperature	-20°C...+60°C
Relative humidity	20%...90%, without condensation
Vibrations during operation	unacceptable
Impulse waves during operation	unacceptable
Direct insulation	unacceptable
Vibrations and impulse waves during transport	According to PN-83/T-42106

**2. Installation.**

**2.1. Requirements.**

The PSU RACK shall be mounted by a qualified installer with appropriate permissions and qualifications for 230V AC installations and low-voltage installations (required and necessary for a given country). The device shall be mounted in confined spaces, according to the environment class II, with normal air humidity (RH=90% max. without condensation) and the temperature from -10°C do +45°C.



**During normal operation the total current consumption of the cameras cannot exceed I=12A. Maximum current consumption of the recorder: 4A. Maximum battery charging current is: 2A.**

**Total device current + battery: 18A max.**

As the PSU is designed for a continuous operation and is not equipped with a power-switch, therefore an appropriate overload protection shall be guaranteed in the power supply circuit. Moreover, the user shall be informed about the method of unplugging (usually through assigning an appropriate fuse in the fuse-box). The electrical system shall follow valid standards and regulations.

**2.2. Installation procedure.**

- 1. Before installation, cut off the voltage in the 230V power-supply circuit.**
- Mount the power supply in a RACK 19" cabinet as shown below:



- Mount M6 cage nuts



- Secure the enclosure with 4xM6 screws

- Connect the receivers' cables to the terminals AUX1...AUX16, DVR.
- If needed, the following technical connections can be made:
  - ALARM – technical output of collective failure
- Connect the battery to the +BAT- terminals:
  - battery output (+): terminal BAT+
  - battery output (-): terminal BAT-
- Connect the ~230V AC power cord with the IEC C13 plug (included) to the 230V AC power supply and turn on the power (~230V).
- Check the PSU operation indicator.

### 3. Operating status indication.

#### 3.1. LED indication.

The PSU has 22 LED lights at the front panel:



GREEN LED:

- on – the PSU is supplied with 230V AC
- off – no 230V AC supply



GREEN LED:

- on – DC voltage at the output of the switch mode PSU
- off – no DC voltage at the output of the switch mode PSU



RED LED:

- on – failure
- off – no failure



RED LED:

- ON – too high temperature of the switch mode power supply (>70°C)
- OFF – standard temperature of the switch mode power supply



RED LED:

- on – battery voltage <11,5V
- off – battery voltage >11,5V

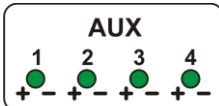

GREEN LED:

- on – DC voltage in the AUX1...AUX16 output
- off – no DC voltage in the AUX1...AUX16 output

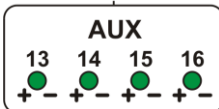

GREEN LED:

- on – DC voltage in the DVR output
- off – no DC voltage in the DVR output

#### 3.2. Technical output.

The power supply is fitted with the **ALARM** output of collective failure (relay type). A collective failure can be triggered by the following events:

- 230V AC mains power failure
- Activation of the glass fuse F1÷F16, F<sub>DVR</sub>
- Failure of the switch mode power supply
- Too high temperature of the switch mode power supply (>70°C)
- Low battery voltage (<11,5V)

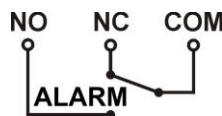

Fig. 4. Electrical diagram of the ALARM collective output of failure.



**CAUTION!** In Fig.4 the set of contacts shows a potential-free status of the relay, which corresponds to power supply failure.



### 3.3. Acoustic indication.

A collective failure is indicated by the piezoelectric indicator, 1 beep every second. The acoustic indication can be turned off by changing the ON / OFF position of the switch (»)).

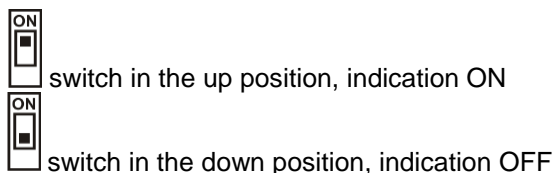

## 4. Operation and use.

### 4.1. Overload or short circuit of the PSU output.

The AUX1 ÷ AUX16, DVR power supply outputs are protected against short-circuit with glass fuses. If a fuse-assisted protection has been chosen, replace the fuse (of the same parameters) in case of a failure.

**4.2 Battery-assisted operation** In case of a main power outage, the device is immediately switched into a battery-assisted operation.



**The PSU is equipped with the discharged battery disconnection system. During the battery-assisted operation, reducing voltage below 9,5V at the battery terminals will cause battery disconnection.**

### 4.3 Maintenance.

Any and all maintenance operations may be performed following the disconnection of the PSU from the power supply network. The PSU does not require performing any specific maintenance measures. In case of fuse replacement, use a replacement of the same parameters.



#### WEEE LABEL

**Waste electrical and electronic equipment must not be disposed of with normal household waste. According to the European Union WEEE Directive, waste electrical and electronic equipment should be disposed of separately from normal household waste.**

**CAUTION!** The power supply unit is adapted for a sealed lead-acid battery (SLA). After the operation period it must not be disposed of but recycled according to the applicable law.

#### Pulsar

Siedlec 150, 32-744 Łapczyca, Polska  
Tel. (+48) 14-610-19-40, Fax. (+48) 14-610-19-50  
e-mail: [biuro@pulsar.pl](mailto:biuro@pulsar.pl), [sales@pulsar.pl](mailto:sales@pulsar.pl)  
http:// [www.pulsar.pl](http://www.pulsar.pl), [www.zasilacze.pl](http://www.zasilacze.pl)